

QUANTA

QT300 QT400

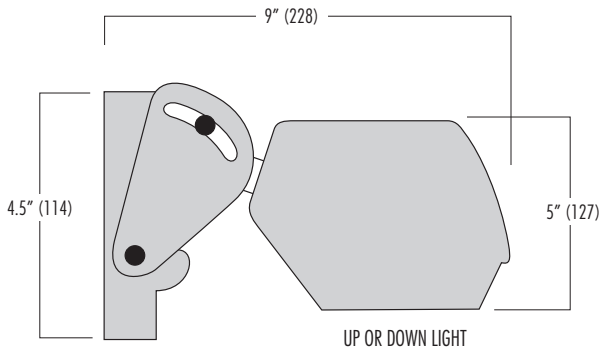
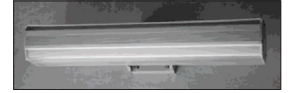

DESCRIPTION

Quanta is perfect for highlighting architectural features or illuminating wide areas on building perimeters. Giving you more control of what you choose to illuminate. Featuring a dark sky friendly full cutoff down light, you will also benefit from various lighting intensities, exceptional lumen efficiency and optional forward throw with on site adjustability.

A standard 15° luminaire tilt with a locking mechanism, allows tuning of light with illuminated surface texture.

Quanta may be installed for exterior or interior lighting applications.

Quanta will provide a min. of 50 ft. of effective wall illumination.

Quanta may be installed in two positions.

DOWN LIGHT: Full cutoff distribution with a set of lenses individually and precisely positioned to provide Type I distribution.

UP LIGHT: Positioned as an up light, Quanta is also perfect for wall or under canopy illumination.

GENERAL SPECIFICATION

FINISH

Five stage preparation process. Polyester powder coating is applied through an electrostatic process and oven cured for longterm durability against harsh weather treatments.

- Extruded aluminum with internal heat sink for effective dissipation of heat
- Fully sealed luminaire with memory retention gasketing
- Clear tempered glass lens
- Weather resistant IP66 connection
- U.V stabilized SE00W power cable meets U.L 62
- Cast aluminum mounting assembly with holder cables to facilitate electrical connections during installation
- Single point mounting with heavy cast aluminum mechanism
- Blind pressure stainless steel fasteners
- Standard 4 K LED's. (Optional 35 K is available)
- U.L listed for wet location IP66

LM79 Independent photometry testing

LM80 Certified components

ELECTRICAL SPECIFICATION

- Power factor > 90% at full load
- Voltage: 120/277V Constant voltage (+/- 10%)
- Frequency: 56/60 HZ
- System efficacy < 50%
- Overheat protection, self-limited short circuit protection and overload protected
- Load regulated from 0 to full load +/- 1%
- LED life rated at min. 70,000 hours
- Exclusive modular PC LED boards. Each module can be easily replaceable on site if required.

Quanta comes standard with a color temperature of 4000° K. Employing only industry-recognized LED manufacturers with ANSI Compliant binning.

Quanta features a 15° tilt adjustment with angular indicators and locking mechanism.

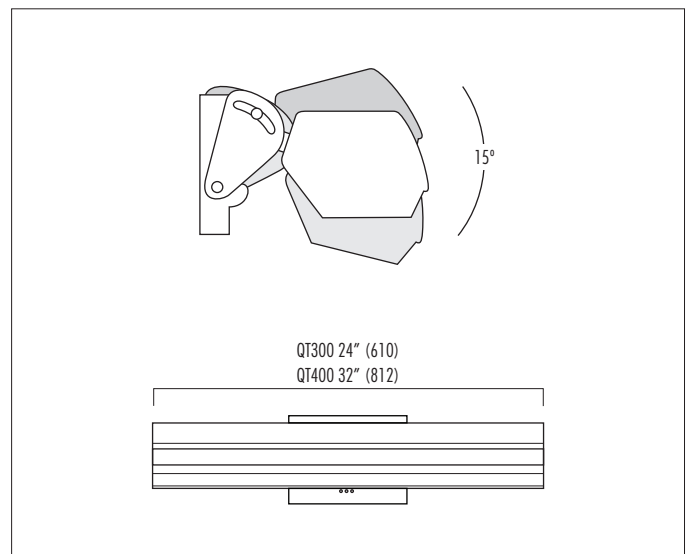

PHOTOMETRY

Please visit our web site www.luminis.com for complete I.E.S formatted download data.

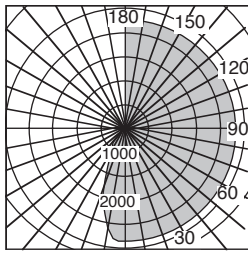

MOUNTING

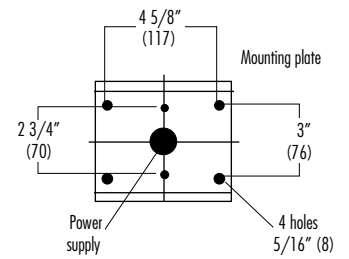

LUMINAIRE SELECTION

LUMINAIRE FOR UP OR DOWN LIGHTING



Up or Down

| | QT300 | QT400 |
|-------------|----------|----------|
| Lens type | Narrow | Wide |
| Input watts | 36 | 48 |
| Total flux | 2052 Lms | 2736 Lms |
| LPW | 52 lms | 52 lms |

Down light position

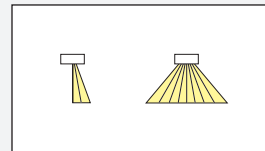

Up light position

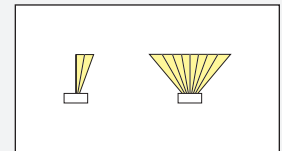

LUMINAIRE FOR UP OR DOWN LIGHTING WITH FORWARD THROW

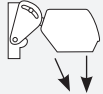

Forward throw FW5/FW6

| | QT300-FW5 | QT400-FW6 |
|-------------|-----------|-----------|
| Lens type | Narrow | Wide |
| Input watts | 54 | 72 |
| Total flux | 3078 Lms | 4104 Lms |
| LPW | 52 lms | 52 lms |

Down light position

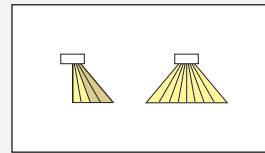

Up light position

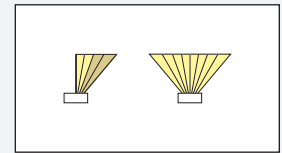

LUMINAIRE FOR UP AND DOWN LIGHTING

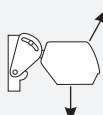

Up light UL3/UL4

| | QT300-UL3 | QT400-UL4 |
|-------------|-----------|-----------|
| Lens type | Narrow | Wide |
| Input watts | 54 | 72 |
| Total flux | 3078 Lms | 4104 Lms |
| LPW | 52 lms | 52 lms |

30 % Up - 70 % Down

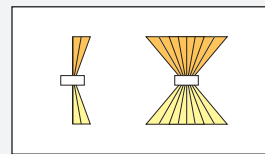

70 % Up - 30 % Down

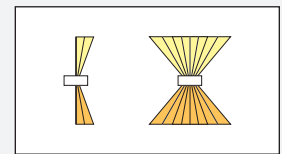

LUMINAIRE FOR UP AND DOWN LIGHTING WITH FORWARD THROW

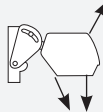

Forward throw FW5/FW6

| | QT300-UL3-FW5 | QT400-UL4-FW6 |
|-------------|---------------|---------------|
| Lens type | Narrow | Wide |
| Input watts | 72 | 96 |
| Total flux | 4104 Lms | 5472 Lms |
| LPW | 52 lms | 52 lms |

25 % Up - 75 % Down

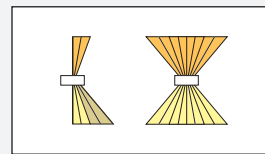

75 % Up - 25 % Down

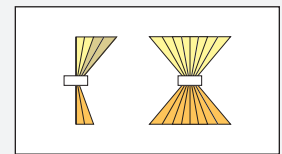

Please add Voltage-Finish & Option suffix (If applicable) to selected catalog number.

VOLTAGE

- 120 V
 277 V

Luminaires are prewired for 120V if no voltage is specified.

STANDARD FINISHES

- WHT:** Snow white
 BKT: Jet black
 BZT: Bronze
 GRT: Titanium gray
 DGT: Gun metal
 CHT: Champagne
 CS: Custom color

(Refer to color chart)

OPTIONS

- K35** 3500° K LED color rendition
 LP Prismatic LED concealing lens 10% loss
 EMQ LED integral emergency battery

LUMINIS

(USA) 3555 NW 53rd Court, Fort Lauderdale, FL.33309 — Toll free: 888.401.6999, Fax: 954.717.4157
(Canada) 260 Labrosse, Pointe Claire (Quebec) H9R 5L5

www.luminis.com

Luminaires may be altered for design improvements or discontinued without prior notice. Unless specified, lamps are not included with luminaires.

MARCH, 2010 **10**