

W614 . W614LS . W618 . W618LS

Specification

All exposed cast aluminum components are made of non corrosive pure aluminum copper free (Aluminum is less than .1% copper content.#356 alloy.)
 The luminaire base assembly is built with a hinge mechanism,allowing to tilt the top part of the luminaire to access the electrical equipment. No tools required. The quick disconnect ballast assembly is installed on a removable tray.
 The lamp is accessible with a twist and lock action.
 The ease of maintenance and lamp replacement concept will leave the optical chamber free of finger prints and foreign particles, Finish: All polyester powder baked coatings preceded with a 5 baths preparation process. Meets military grade MIL-C781706 with a 2000 hours salt spray test.

- Pulse rated porcelain socket or 75W/600V thermoplastic compact fluorescent socket.
- One-piece molded silicone gasket with memory retention.
- High power factor CWA ballast. Or 98% P.F. electronic smart ballast with end of life detection for compact fluorescent.
- All stainless steel hardware.
- All Moving and removable parts are sealed with a memory retention silicone gasket.

- 1- Min. .093" hard aluminum shade, with underside white enamel to maximize light performance.
 - 2- 1/2" dia. solid aluminum struts.
 - 3- White translucent U.V. protected high impact acrylic cylindrical diffuser.
 - 4- Cast Aluminum built-in hinge mechanism.
 - 5- Cast Aluminum ballast housing with dissipation fins to maximize heat dissipation and cool operation of ballast.
 - 6- Cast Aluminum swing out housing,with safety cable retainer. Push release button for quick access to electrical equipment. (No tools required for maintenance.) Button may be locked for limited access. (See option LB1)
- 7- **W618 & W618LS**: Set of 3 interlocked cast aluminum louver blades.

Photometry

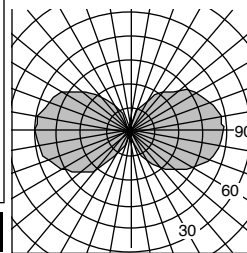

Separate updated technical specification sheets with related models and light sources are available on www.luminis.com.

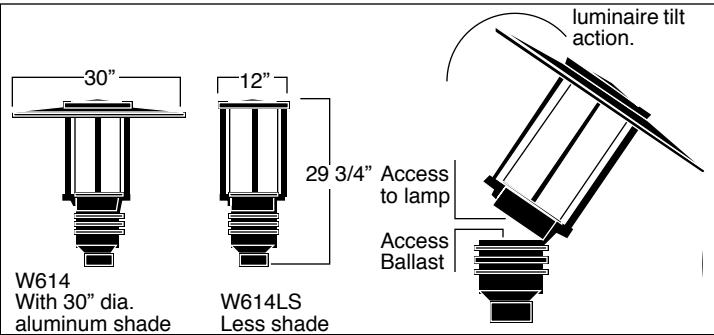
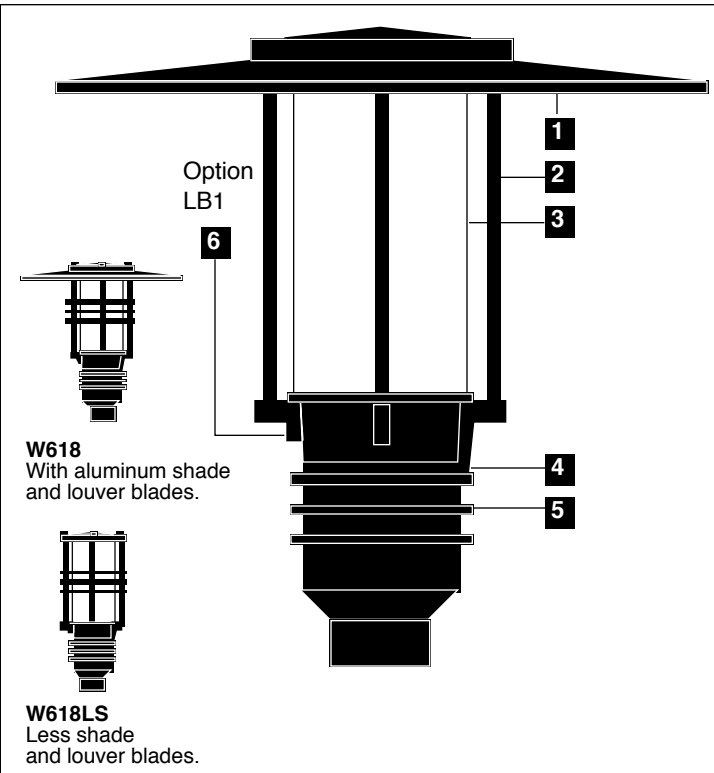

Certification

UL. Wet Location.

Mounting & E.P.A.

E.P.A: 1.2 sq./ft Max. weight: 38 lbs.
 Installation: Mounts over a 4" or 5" O.D. Pole.X 4"ø tenon.

For options details and specifications, please refer to pages **41.42.43**

Model#	Mounting	Light source selection	Voltage	Finish	Options
<input type="checkbox"/> W614 <input type="checkbox"/> W618	Optional	MH (ED17)	120 V Standard factory prewired (If no voltage is specified) For other voltages, please specify with catalog number.	Standard selection	Accessories
	<input type="checkbox"/> ACA1 <input type="checkbox"/> ACW1 <input type="checkbox"/> EC3P <input type="checkbox"/> EC3W	<input type="checkbox"/> M70 <input type="checkbox"/> M100 <input type="checkbox"/> M150 <input type="checkbox"/> M175			
<input type="checkbox"/> W614LS <input type="checkbox"/> W618LS	<input type="checkbox"/> ACA1 <input type="checkbox"/> ACW1 <input type="checkbox"/> EC3PS <input type="checkbox"/> EC3WS	HPS (ED17)	H.I.D.	Optional colors	Available with W614LS & W618LS only.
	<input type="checkbox"/> QL lamp. (Including: generator, power coupler & discharge vessel) 120V	<input type="checkbox"/> H70 <input type="checkbox"/> H100 <input type="checkbox"/> H150	Single lamp	<input type="checkbox"/> 208 V <input type="checkbox"/> 120V <input type="checkbox"/> 240 V <input type="checkbox"/> 277 V <input type="checkbox"/> 347 V <input type="checkbox"/> 480 V	<input type="checkbox"/> DGT: Gun metal <input type="checkbox"/> CHT: Champagne <input type="checkbox"/> MST: Matte silver <input type="checkbox"/> GNT: Forest green
		Two lamps	INDUCTION QL	Electrical	
		<input type="checkbox"/> F157 <input type="checkbox"/> F170 <input type="checkbox"/> F185 <input type="checkbox"/> F120	COMP. FLUO.	<input type="checkbox"/> CS: Custom color <input type="checkbox"/> RAL: RAL# color	<input type="checkbox"/> FS: Fuse <input type="checkbox"/> PH1: 120/277V photo cell <input type="checkbox"/> PH2: 347V photo cell
		Four lamps	Smart ballast 120/277		
		<input type="checkbox"/> F232 <input type="checkbox"/> F242 <input type="checkbox"/> F257 <input type="checkbox"/> F270 <input type="checkbox"/> F426 <input type="checkbox"/> F432	<input type="checkbox"/> 347 V (To specify)		
		<input type="checkbox"/> Q55 <input type="checkbox"/> Q85			

(Lamps by others. Except for QL lamps)

Luminaires may be altered for design improvements or discontinued without prior notice.

Push Release button lock

Option: **LB1**

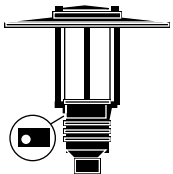

For restricted access.
Locked push button.
Requires 8-32 hexagonal
key to release.

General notes:
Please specify selected option as a
suffix to luminaire model number.
ex: W614-M100-WHT-LB1
Each model is provided with a
listing of compatible options. Some
options may not be compatible
when used in the same luminaire.
Please check listings.

Reflector disc

Option: **OS**

Aluminum oblong
reflector disc.
(Factory installed)
Applicable to
W632 & W640

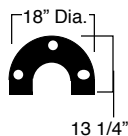

House side shield

Option:

H2 For post top
luminaires
H1 For bollard mount
luminaires.



Exterior white
enamel, and specular
aluminum inner
reflective surface.
The shield is inserted
and snaps inside the
diffuser.
360° on site rotation.

Slope ceiling adaptor

Option: **SW45**

45° hang straight
ball swivel
for 5/8" dia.
suspension stem.

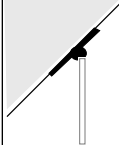

Suspension safety cable

Option: **STC**

Additional safety
cable, extended
12" beyond
canopy



Adjustable down light (W780 series)

Option: **DL4**

50W / MR16 adjustable down light
Available with 120V power input. For other
voltages, please consult factory
Note: Other down light sources than shown with
option DL4 are available. Please consult factory.

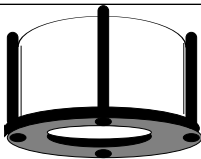

Type III reflector

Option: **RF3 / RA3 / RL3 / PR3**

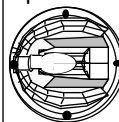

Type III Multifaceted
specular reflector.
(Single lamp only.)

Suspension stem

5/8" O.D. suspension stem.



STM60 60" lg.

STM80 80" lg.

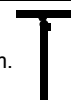
For other factory cut to size length
add suffix **-STM** with desired
length to catalog# max. 120"



Light distribution control

-  Option: Type III light
distribution
refractor
R3
-  Option: Type IV light
distribution
refractor
R4

Semi frosted diffuser

Option: **LF1**

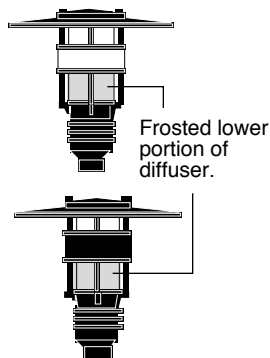

Frosted lower
portion of
diffuser.

Type IV reflector

Option: **RF4 / RA4 / RL4**

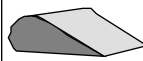

Type IV
Forward throw
aluminum specular
reflector. (Single
lamp only.)

Lamps & ballast

compatibility

Compact Fluorescent

Lamp Watts	Lamp base
26W	G24Xq3
32W	G24Xq3
42W	G24Xq4
57W	G24Xq5
70W	G24Xq6
85W	2G8-1
120W	2G8-1

Metal halide

Lamp Watts	Lamp base	ANSI Code
39W	T6/G12	M130
50W	ED17	M110/M148
70W	ED17	M198/M143
70W	T6/G12	M139
100W	ED17	M90/M140
150W	ED17	M102/M142
150W	T6/G12	M142
175W	ED17	M57

Wall mount light options

Option: **DL1**
DL1-277
12V/50W MR16
Down light with integral
120/12V or 277/12V
electronic transformer.
other input voltages on
request.

Option: **DL2**
Open sealed
top cover
allowing up-
lighting

Option: **DLC**
DL1 / DL2
Combination.



Emergency battery pack

For 57w & 70w: Consult factory

EM42

One lamp:
26w: 450 Lmns..
32w: 575 Lmns.
42w: 750 Lmns.

Time: 90 Mnts -120/277V T 0° C

**Please refer to page 72 for
more details**

Fuse

Option



FS
Ballast protection fuse
Available with H.I.D.
luminaires only

Note: FS option fuse is factory
calibrated and installed with
selected wattage.

Post mount luminaires:
FS installed with pole.

All other types:
FS is installed with luminaire.

Light photo sensor

Option: **PH1** -120V
PH2 - 277 / 347V

Photo electric sensor,
factory installed with the pole
or inside fixture when pole is
not required.



Quartz lamp restrike

Option: **QRS**

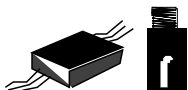

Quartz restrike standby lamp kit.
When power failure is restored, it will
energize temporary Quartz lamp with
progressive dimming until full H.I.D
light output is produced.
max.100w DC bayonet type.
(Lamp is not included.)
Not Applicable with CFL lamps.

Quartz lamp restrike

Option: **QS**



Quartz lamp socket for external 120V
emergency power input.
Separate 120V dedicated wiring is included.
max.100 W DC bayonet type.
(Lamp is not included.)
Not Applicable with CFL lamps.

Luminaires may be altered for design improvements or discontinued without prior notice.

LUMINIS [USA] - 3555 NW 53rd Court, Fort Lauderdale, FL.33309
LUMINIS [Canada] - 87 C Brunswick D.D.O. Q.C. Canada H9B 2J5

Tel: 954 .717 .4155 Fax: 954 . 717.4157
Toll free: 888 .401 .6999

Web: www.luminis.com
Sept. 2006 Rev. Feb.2007

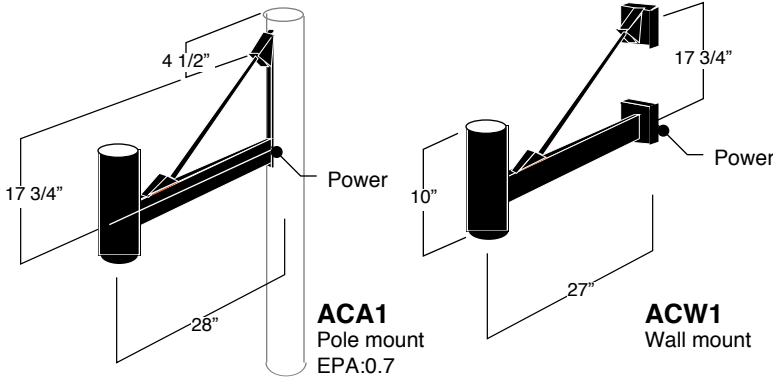

ACA1
Pole mount
EPA:0.7

ACW1
Wall mount

ACW1 series
Mounting

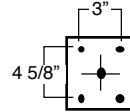

EC3W
EC3WS
series
Mounting

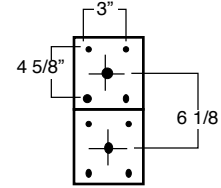

ACA1/ ACW1 -1" x 3" extruded aluminum side pole or wall mounting adaptor. 1/2" dia. stainless steel rod support. 10" x 4" o.dia. aluminum tenon.

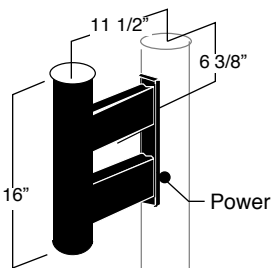

EC3PS -1" x 3" extruded aluminum twin short arm side pole mounting adaptor designed to fit with 4 to 5" dia. poles. 16" lg. X4" o.d. tenon. This option is applicable only to catalog numbers with the suffix **LS** EPA:0.72

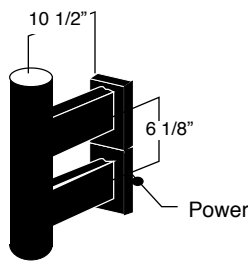

EC3WS -1" x 3" extruded aluminum twin short arm mounting adaptor designed for wall installation, with a set of two cast aluminum mounting plates. This option is applicable only to catalog numbers with the suffix **LS**

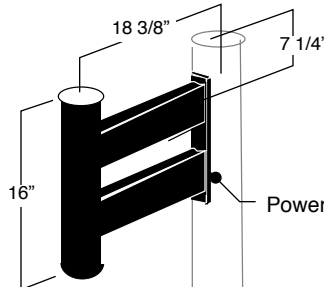

EC3P -1" x 3" extruded aluminum twin extended arm side pole mounting adaptor designed to fit with 4 to 5" dia. poles. 16" lg. X4" o.d. tenon. EPA:0.97

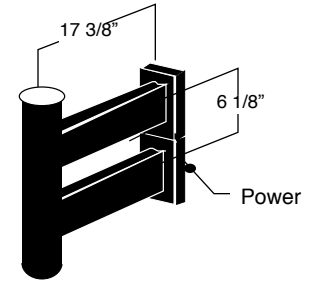

EC3W -1" x 3" extruded aluminum twin extended arm mounting adaptor designed for wall installation, with a set of two cast aluminum mounting plates.

Please specify selected option with a suffix to the specified model number.

Ex: W624LS-EC3WS-EC5 M100-WHT

23/30" dia. aluminum double adjustable dropped shade

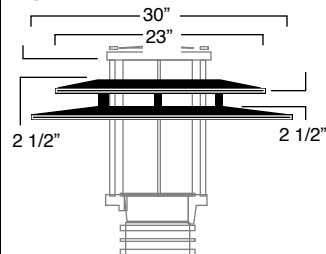

Set of two .093" thick hard aluminum shades factory prefixed. The underside is standard white enamel to optimize lighting performance. The set of shades can slide along the diffuser to accommodate various landscape viewing angles. Note: The distance between the two shades is fixed.

Option: **EC6** EPA:0.44

Compatible with:
ACA1 EC3P
ACW1 EC3W

30" dia. aluminum single adjustable dropped shade

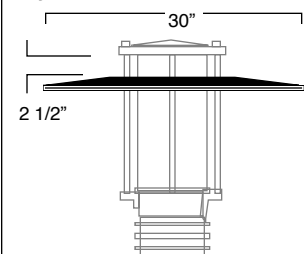

.093" thick hard aluminum factory prefixed dropped shade. The underside is standard white enamel to optimize lighting performance. The shade can slide along the diffuser to accommodate various landscape viewing angles.

Option: **EC7** EPA:0.25

Compatible with:
ACA1 EC3P
ACW1 EC3W

18" dia. cast aluminum adjustable shade

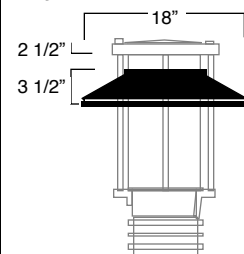

3/16" thick cast aluminum shade for applications where heavy traffic requires indestructible materials. The underside is standard white enamel to optimize lighting performance. The shade can slide along the diffuser to accommodate various landscape viewing angles.

Option: **EC5** EPA:0.26

Compatible with:
ACA1 EC3P EC3PS
ACW1 EC3W EC3WS

Pier or short wall top mount

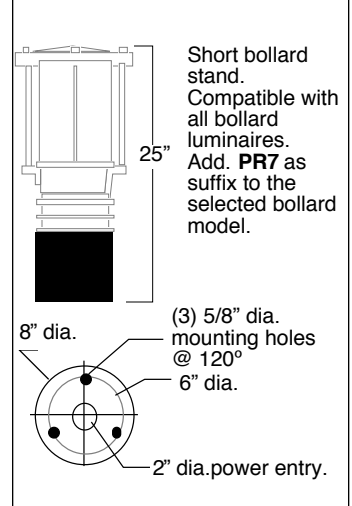

Short bollard stand. Compatible with all bollard luminaires. Add **PR7** as suffix to the selected bollard model.

Option: **PR7**

Compatible with:
W788 TO W791 Bollard series.

Luminaires may be altered for design improvements or discontinued without prior notice.

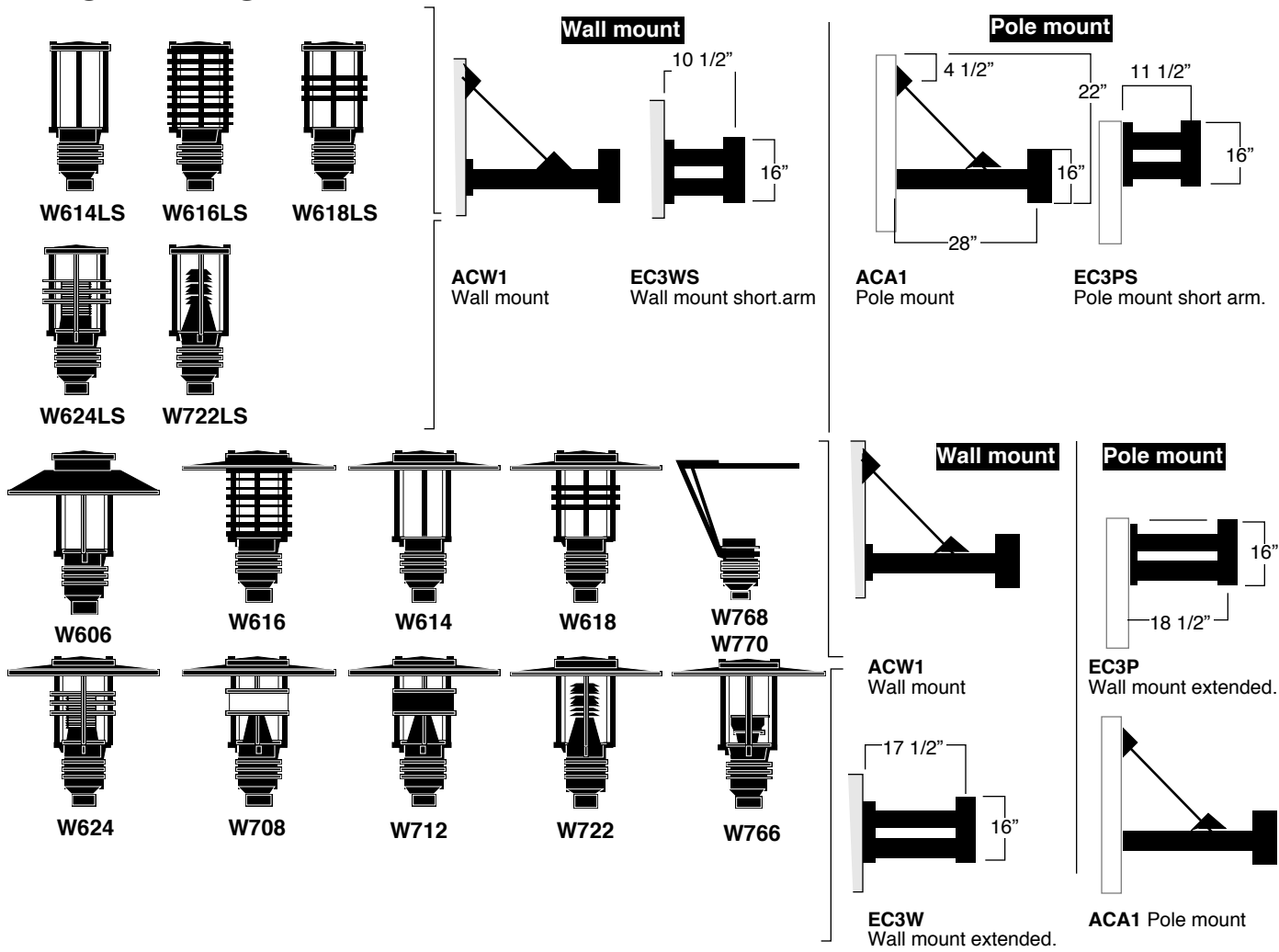

* Note:
36" extension with ACA attachment
24" extension with EC3P attachment

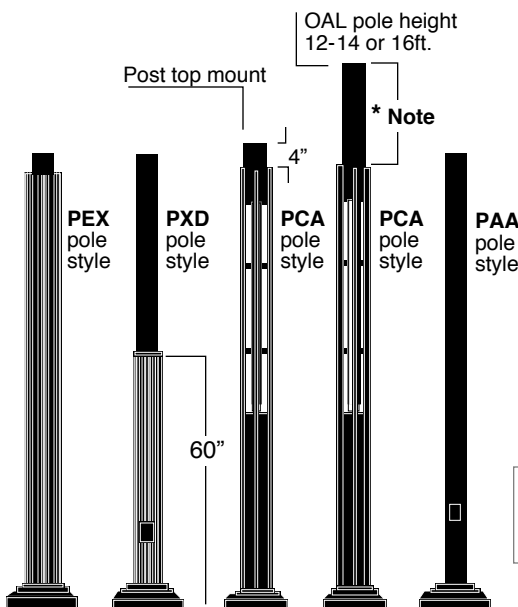

Compatible poles listing.

		Post top mounting				Pole height	
Mounting style		4"O.D.	5"O.D.	4"O.D.	4"O.D.		
		PAA410	PAA510-A	PCA10	PEX10	PXD10	10 ft
		PAA412	PAA512-A	PCA12	PEX12	PXD12	12 ft
		PAA414	PAA514-A	PCA14	PEX14	PXD14	14 ft
		PAA416	PAA516-A	PCA16	PEX16	PXD16	16 ft
		PAA418	PAA518-A		PEX18	PXD18	18 ft
		PAA420	PAA520-A		PEX20	PXD20	20 ft
Post side mount with EC3P attachment accessory							
		PAA410-C3P	PAA510-C3P				10 ft
		PAA412-C3P	PAA512-C3P	PCA12-C3P	PEX12-C3P	PXD12-C3P	12 ft
		PAA414-C3P	PAA514-C3P	PCA14-C3P	PEX14-C3P	PXD14-C3P	14 ft
		PAA416-C3P	PAA516-C3P	PCA16-C3P	PEX16-C3P	PXD16-C3P	16 ft
		PAA418-C3P	PAA518-C3P		PEX18-C3P	PXD18-C3P	18 ft
		PAA420-C3P	PAA520-C3P				20 ft
Post side mount with ACA1 attachment accessory							
		PAA414-ACA	PAA514-ACA	PCA14-ACA	PXD14-ACA		14 ft
		PAA416-ACA	PAA516-ACA	PCA16-ACA	PXD16-ACA		16 ft
		PAA418-ACA	PAA518-ACA		PXD18-ACA		18 ft
		PAA420-ACA	PAA520-ACA		PXD20-ACA		20 ft

For poles details and specification, please refer to pages 140 to 144

Luminaires may be altered for design improvements or discontinued without prior notice.